



Performance is everything.™

Steam Cleaner Home Pro

User Guide



Vax Careline: (AU) 1300 361 505
(NZ) 0800 800 900

Machine Overview

- 1 Carry handle
- 2 Water tank lid
- 3 On/off button
- 4 Steam ready (green LED)
- 5 Water heating (orange LED)
- 6 Variable steam dial
- 7 Hose inlet
- 8 Tool storage (hidden)
- 9 Steam handle and hose
 - a) Extension tube release
 - b) Safety latch (hidden)
 - c) Steam trigger
 - d) Detergent tank cap
 - e) Detergent control dial (hidden)
- 10 Metal brush
- 11 Detail nozzle
- 12 Small plastic brush
- 13 Large plastic brush
- 14 Scraper tool
- 15 Concentration nozzle
- 16 Window squeegee/upholstery tool
- 17 Velcro microfibre pad (x1)
- 18 Floor head
- 19 Measuring jug
- 20 Funnel
- 21 3pc extension tubes
- 22 Upholstery tool cloth (x2)
- 23 Carpet glider

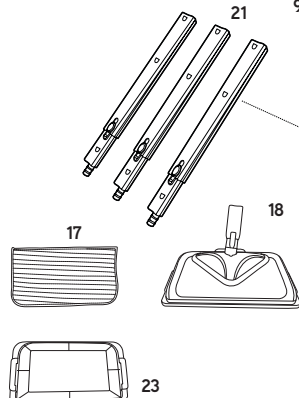
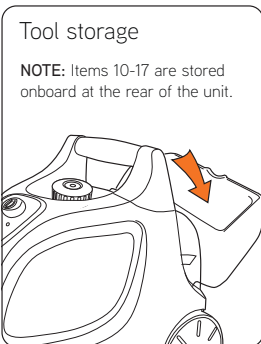
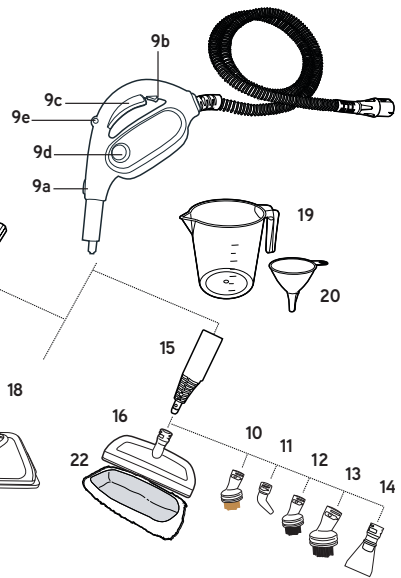

General Safety Information

FOR HOUSEHOLD USE ONLY.

When using the steam cleaner, basic safety precautions should always be observed, including the following:

IMPORTANT: Please refer to floor manufacturer's care recommendations before use and test the steam cleaner on a discrete area of flooring to begin with.

When using the steam cleaner, basic safety precautions should always be observed, including the following:

WARNING: The stick steam cleaner head gets very hot during operation.

WARNING:  Danger of scalding

1. Do not leave the steam cleaner unattended when plugged in. Unplug the product from the socket when not in use.
2. Only use the steam cleaner indoors. Keep the steam cleaner away from rain and moisture.
3. Turn off the on/off switch on the steam cleaner controls before disconnecting or connecting from the mains supply.
4. Always unplug the steam cleaner and allow it to cool before connecting or disconnecting the hose or accessories.
5. Children should be supervised to ensure that they do not play with the appliance.
6. This appliance is not intended for use by children and persons with reduced physical, sensory or mental capabilities or lack of experience and knowledge, unless they have been given supervision or instruction concerning use of the appliance by a person responsible for their safety.
7. The appliance should only be used as described in this User Guide.
8. Only Vax recommended attachments should be used with this appliance.
9. Do not use this steam cleaner if it has been dropped, damaged, left outdoors or dropped into water. Do not use this steam cleaner with a damaged cord or plug. If the supply cord is damaged return the steam cleaner to a Vax authorised Service Agent.
10. Do not pull or carry this appliance by the cord. Do not use the cord as a handle, close a door on the cord or pull the cord around sharp edges or corners. Do not run the steam cleaner over the cord. Keep the cord away from heated surfaces.
11. Do not unplug the product by pulling on the cord.
12. Do not handle the plug or the steam cleaner with wet hands.
13. Do not use without the tank cap in place. Ensure that the water tank cap has been screwed down fully before use.
14. Do not touch any hot areas on the steam cleaner. It is normal for the steam cleaner to heat up during operation.
15. Accessories will become hot during use – allow them to cool down before handling.
16. Do not use the steam cleaner to treat any items of clothing that are still being worn on the body.
17. The force and heat of the steam may have an adverse effect on some materials. Always check whether a surface is suitable for treatment with the steam by carrying out a test before hand on a concealed area.
18. The steam cleaner must be kept level during operation.
19. Never immerse the steam cleaner in water or in other liquids.
20. Do not operate the steam cleaner without water in the tank. Always top up with water in good time.
21. Always remove the mains plug from the socket and allow the steam cleaner to cool down completely before topping up with water.
22. Never aim the steam cleaner at people, animals or plants (there is a risk of scalding). Never touch the steam jet from a short distance with your hands. Do not aim the steam cleaner at electrical items or wires.
23. Keep hair, loose clothing, fingers and all parts of the body away from openings.
24. Never fill the water tank with anything other than water. Never put additives (such as perfume, stain remover or products containing alcohol) in the water as they may damage the steam cleaner or make it dangerous to use.
25. Only carry the steam cleaner by the carry handle.
26. Store the steam cleaner in a cool, dry area.
27. Do not use an extension cord with this product.
28. Using improper voltage may result in damage to the steam cleaner and possible injury to the user. The correct voltage is listed on the rating label.
29. Do not use your steam cleaner if it is damaged or faulty. Please make sure that the product is unplugged from the mains and call the Vax Careline on AU 1300 361 505 / NZ 0800 800 900.
30. Do not use the unit on leather, wax polished furniture or floors, synthetic fabrics, velvet or other delicate steam or water sensitive materials.
31. Do not use on acrylic surfaces.
32. In wet rooms, e.g. bathrooms, connect the appliance to sockets with an RCD adaptor connected in series.
33. The device should not be used to clean electrical appliances such as ovens, microwaves, televisions and electrical heating systems etc.

General Safety Information

34. Be very careful when cleaning tiled walls with sockets.
35. Keep the unit on the floor.
36. Empty the water tank when the steam cleaner is not in use.
37. Do not overfill the tank. Do not exceed the maximum prescribed filling level. Please use the measuring jug and funnel included.
38. Always show these instructions to a third party if you are passing the steam cleaner on to them.
39. Please ensure all parts are correctly fitted before using the product.
40. Do not attempt to remove blockages with sharp objects as they may cause damage.
41. Do not use without the hard water filter in place.
42. Take extra care when cleaning on the stairs.
43. Keep cleaning area well lit.
44. Please refer to the manufacturers care recommendations before use and test the steam cleaner on a discrete area of flooring to begin with.



WARNING: Never leave the steam cleaner in one spot on any surface for an extended period of time as this may damage the floor surface.



IMPORTANT: This steam cleaner may not be suitable for all floating floorboards or sealed floors – please check with your floorboard manufacturer first prior to use.

This machine is intended for household use only, and NOT for commercial or industrial use.

PLEASE KEEP THESE INSTRUCTIONS FOR FURTHER USE.



WARNING: Always switch off and unplug the steam cleaner from the electrical outlet before assembling, opening or emptying the water tank, or before connecting/disconnecting the attachments.



IMPORTANT: The liquid or steam must not be directed towards equipment containing electrical components, such as the interior of ovens.



IMPORTANT: The steam cleaner is equipped with a thermostat and a thermal cut-out. If for any reason the unit should overheat, the thermostat will automatically turn the unit off. Should this occur, unplug the steam cleaner from the electrical outlet and turn off the switch. Let the unit cool, remove and empty the water tank. To re-start the machine, plug it into an electrical outlet and switch it back on.



IMPORTANT: We recommend the use of a Residual Current Device with a Residual Current rating of 30mA or less.

Getting Started

Assembling your steam cleaner

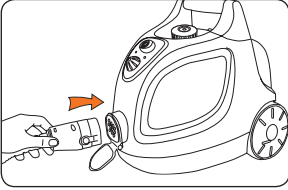

Attach hose to unit.

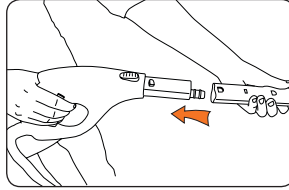

Attach extension tube to handle.

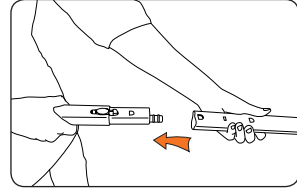

Attach extension tubes together.
To remove the tube/s press the white release button.

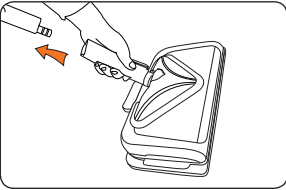

Attach extension tube to floor head.

Attaching small tools

IMPORTANT: Do not attach/remove accessories while steamer is in use. (Hot water may drip out of the accessory-risk of scalding)

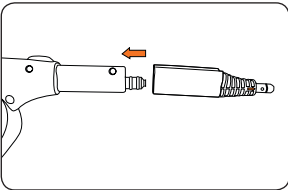

Attach concentration nozzle to handle or extension tube.

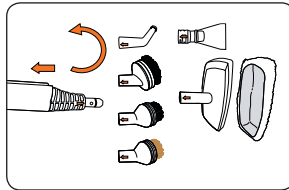

1. Push small tools onto concentration nozzle aligning arrows.

2. Twist clockwise to fit.

Concentration nozzle must be attached before fitting the small tools.

Getting Started

Attaching the velcro microfibre cleaning pad

For use on sealed hard floors or refreshing carpets.

WARNING: To reduce the risk of personal injury, unplug the steamer when fitting the cleaning pads.

IMPORTANT: Never use the steam cleaner without a cleaning pad attached to the floor head.

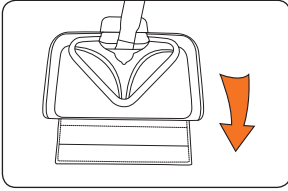

Place the floor head on top of the velcro microfibre pad making sure the mop head covers the entire pad. The blue face should be in contact with the floor and velcro side attaches to the floor head.

Before you begin cleaning

IMPORTANT: Your detergent control dial will be set to 'tough stains' when you remove your steamer from the box. If you do not want to use detergent on your hard flooring/hard surfaces, this must be rotated to the 'steam/refreshes carpets only' position. **Always test on an inconspicuous area of flooring/surface first before using detergent.**

Filling clean water tank

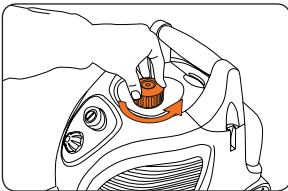

To remove lid, rotate anti-clockwise.

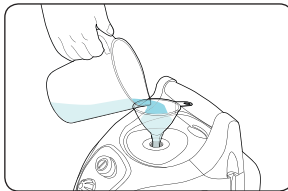

Using the measuring jug and funnel, only fill up to 1.4L. Allow space to be left at the top.

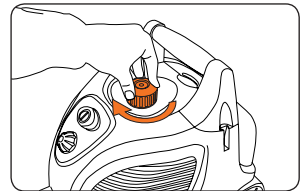

Ensure the lid is securely fastened by rotating clockwise before use.

IMPORTANT: Do not use hot or boiling water to fill clean water tank. Do not over fill the water tank.

IMPORTANT: Do not operate your steam cleaner without water in the clean water tank.

Getting Started

Filling detergent tank

IMPORTANT: Do not mix Vax detergent with any other cleaning detergent. This product can be used with or without detergent.

Detergent tank is located in the hose/handle assembly.

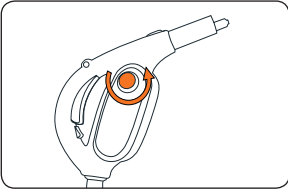

Place the hose/handle assembly on a flat surface. Unscrew the detergent tank cap by turning anti-clockwise.

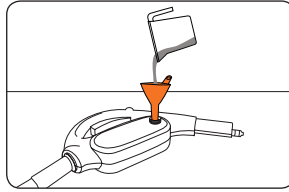

Pour 50ml of Vax detergent and 150ml of water using the measuring jug, into the detergent tank. Attach the detergent tank cap and tighten by twisting clockwise.

50ml detergent plus 150ml water to 1 clean water tank.

Refilling water during operation

IMPORTANT: Turn off the steamer and unplug from electrical socket before filling up the clean water tank.

IMPORTANT: Wait 10 minutes until the safety pressure indicator has gone down, which indicates the steamer has cooled. If after this time the indicator has not fully dropped, release residual steam pressure by pressing steam trigger on handle and then gently pushing the safety pressure indicator. Slowly unscrew the tank lid anti-clockwise but do not remove. Allow steamer to cool an additional 5 minutes. After you have ensured steamer has cooled and pressure has been released the water tank lid should turn freely to remove. Remove any remaining water to avoid overfilling. Return to 'filling clean water tank'.

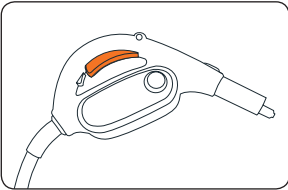

Press steam trigger to release pressure.

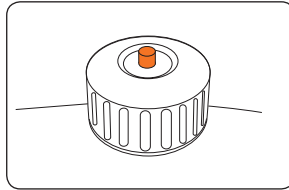

When tank is under pressure, the safety pressure indicator (red) will rise above the surface of the lid.

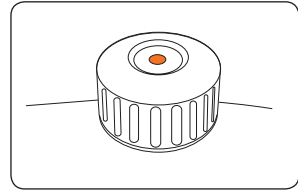

When the tank is not under pressure, the indicator will be flush or below the surface.

How To Use

Steam cleaning hard floors

WARNING: Never leave the steam cleaner floor head in one spot on any surface for an extended period of time with a damp or wet pad attached as this may damage the floor surface. Your steam cleaner should only be used on sealed floors including tiles, lino, wood flooring and laminate.

WARNING: This steam mop may not be suitable for all floating floorboard - please check with your floor manufacturer first prior to use.

IMPORTANT: Please refer to the floor manufacturer's care recommendations before use and test steam mop on a discrete area of flooring to begin with.

WARNING: To reduce the risk of personal injury, unplug the steam cleaner when assembling the accessories.

Do not operate the steam cleaner without water in the clean water tank.

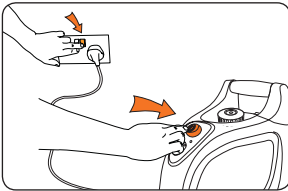

Plug into mains, turn on and press power button on.

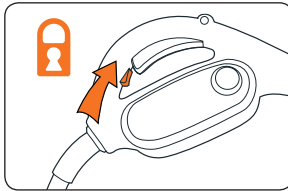

Ensure steam handle safety latch is on.

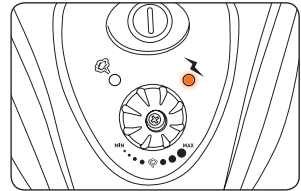

Orange LED will illuminate when water is heating.

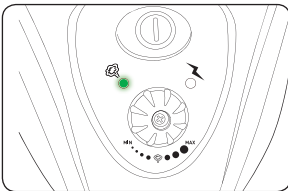

After approximately 12 minutes the Green LED will illuminate showing steamer is ready to use.

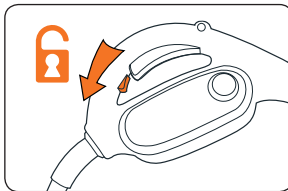

Release steam handle safety latch.

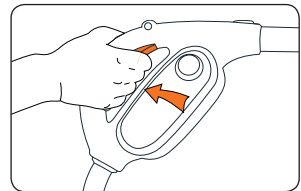

To produce steam, squeeze the trigger in short bursts. To prevent overly wetting floors, do not hold down continuously.

How To Use

Steam cleaning hard floors (cont)

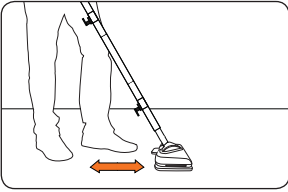

When cleaning sealed hard floors, move the steamer slowly backwards and forwards paying particular attention to high traffic areas. Squeeze/release trigger as required.

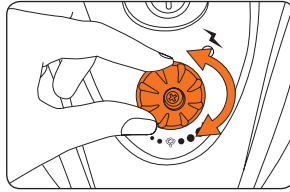

Rotate variable steam dial to adjust pressure.

1 x 1.4L water tank = 40 minute steaming time (approx)

Orange light = water heating

Green light = steamer ready to use

No green light = water heating to maximum temperature. (Note: you can still use your steamer at this time).

If during use the green light switches off, this means the steamer is heating up to maximum temperature. The green light will re-appear when it has heated back up to maximum temperature.

To clean with steam detergent

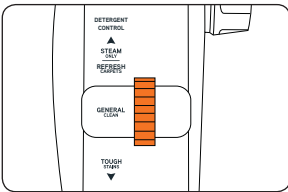

This product can be used with and without detergent. To use with detergent turn the detergent control dial to desired setting for the area you want to clean. Squeeze/release trigger to dispense detergent.

WARNING: Only use recommended Vax Steam Detergent.

IMPORTANT: Please refer to the floor manufacturer's care recommendations before use and test steam mop on a discrete area of flooring to begin with.

How To Use

Refreshing carpets

IMPORTANT: When using on carpets, always ensure the velcro microfibre cleaning pad is properly attached to the floor head.

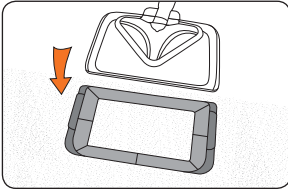

Place floor head (with velcro microfibre pad attached) into carpet glider.

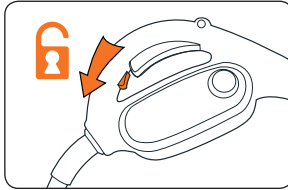

Release steam handle safety latch.

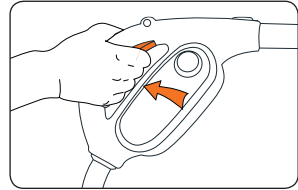

To produce steam, squeeze the trigger in short bursts. To prevent overly wetting, do not hold down continuously.

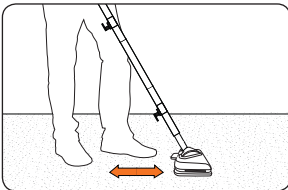

Move the steamer slowly backwards and forwards paying particular attention to high traffic areas.

How To Use

Using the small tools

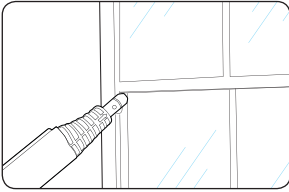

Concentration nozzle

Use to remove soap scum in baths and shower enclosures and to clean heavily soiled areas in kitchens.

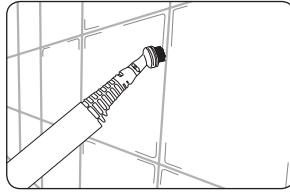

Brushes

Agitate stubborn grease and grime.



Metal brush

For oven grills and racks.

IMPORTANT: Test a hidden area before use. Do not use on non-stick surfaces.

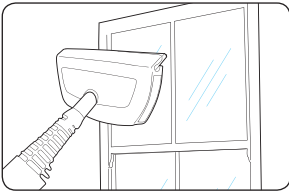

Window squeegee tool

Great for leaving your windows, tiles and mirrors gleaming.

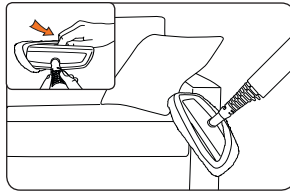

Upholstery tool

Attach the cloth to the squeegee tool for use on upholstery and clothes. **Do not use detergent on fabrics and upholstery.**

IMPORTANT: Test for colour fastness in a small hidden area of upholstery/fabric to check for colour removal before use.

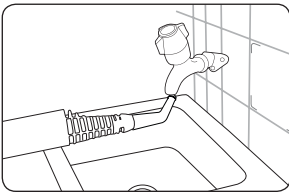

Detail tool

For hard to reach areas e.g. around taps.

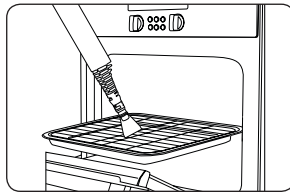

Scraper tool

Ideal for removing dried on residue from in oven grills, work surfaces and pans.

Looking After Your Machine

Emptying the clean water tank

IMPORTANT: Allow the unit to fully cool down before performing any maintenance or troubleshooting checks.

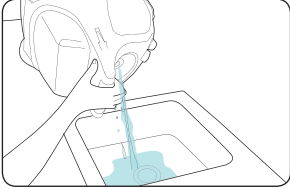

Empty unit of any remaining water.

Emptying the detergent tank

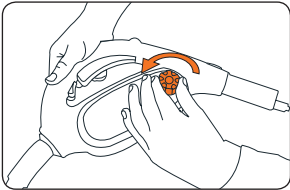

To remove lid, rotate anti-clockwise.

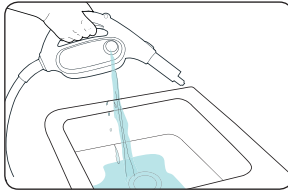

Ensure detergent tank is emptied and rinsed out with tap water after each use.

Removing the velcro microfibre cleaning pad

IMPORTANT: Allow the unit to fully cool down before performing any maintenance or troubleshooting checks.

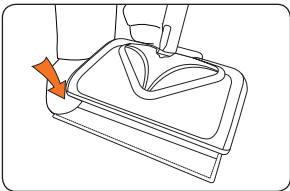

Once cooled, lift microfibre cloth from floor head by releasing the velcro grip.

Looking After Your Machine

Cleaning the pads

IMPORTANT: Never use bleach or fabric softener when washing the cleaning pad.

1. Machine washable at warm temperature (40°C max). Always use a mild detergent.
2. Allow to fully dry before use (24 hours) or tumble dry on a low heat..

After steamer use/storage

IMPORTANT: Steam cleaner must have completely cooled down before storing.

IMPORTANT: To maintain your steam cleaner's performance, turn the unit off at the plug and hold steam trigger down to release remaining steam pressure. Wait for unit to completely cool down before carrying out any maintenance work. Ensure the water tank has been fully emptied and detergent tank rinsed. The unit should be wiped down with a dry cloth before storage.

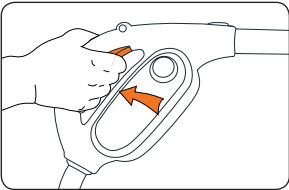

Press steam trigger to release steam.

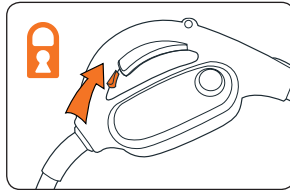

Ensure steam handle safety latch is on.

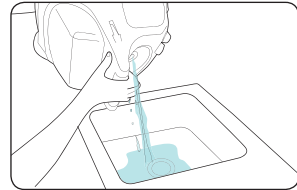

Empty unit of any remaining water.

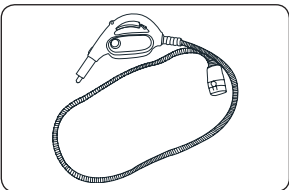

Hose can be hung up or loosely stored in box. Hose must not be tightly wound during storage.

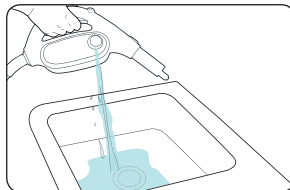

Ensure detergent tank is emptied and rinsed out with tap water before storing your unit.

Looking After Your Machine

WARNING: to reduce the risk of personal injury, unplug the steamer and ensure unit has fully cooled down before performing maintenance/troubleshooting checks.

What do I do if the machine/an accessory has become damaged or broken?

- Visit vax.com.au for spares and parts.
- Please call our Careline to purchase new spares or order a replacement.

What to do if the steam cleaner has no power?

- The unit may not be plugged into an electrical socket; ensure the plug is pushed in securely.
- Check the mains power is switched on.
- The electrical socket may not be working; check the fuse or breaker and consult an electrician.
- The power cord may be damaged; if it is it must be replaced by the manufacturer, or a Vax authorised service agent.

Why is the steam cleaner not producing steam?

- Ensure that the mains power is switched on and the power button has been pressed on the unit.
- There may be no water in the tank; please refer to the operation section.
- Check that the safety latch has been unlocked on the steam handle.
- Check that the unit has not been overfilled, as there must be space in the tank for the water to heat. If overfilled the unit will deliver little steam or water droplets.
- The water may not yet be at temperature; the green steam ready indicator light will illuminate when the water is at temperature and is ready to use.
- If the unit is producing a very small amount of steam, check the variable steam power dial and adjust to max.
- If none of the points above are of assistance, we're here to help. Simply call us on AU: 1300 361 505 / NZ: 0800 800 900
- When the unit has been switched off and fully cooled remove the water tank lid. If limescale build up can be seen inside the tank the unit will need to be descaled.

What do I do if the steam cleaner takes a long time to heat up?

- When the unit has been switched off and fully cooled remove the water tank lid. If limescale build up can be seen inside the tank the unit will need to be descaled.
- Otherwise, we're here to help. Simply call us on: AU: 1300 361 505 / NZ: 0800 800 900

we're here to help

For troubleshooting please call or visit our website:

AU: 1300 361 505
vax.com.au

NZ: 0800 800 900
vax.co.nz

This does not affect your statutory rights

Other Information

Service & Help

Vax Careline:

(AU) 1300 361 505

(NZ) 0800 800 900

Monday-Friday 8.30am to 5.00pm

Any queries or concerns about using your Vax, call the Vax Careline. Calls are charged at the standard local rate. Please make a note of the serial number and model number of the steam cleaner before calling. For the nearest Service Agent, please call the Vax Careline or visit vax.com.au

Technical Specification

| | |
|--------------------------|---------------------|
| Voltage: | 220-240V ~ 50Hz |
| Wattage: | 1400-1600W |
| Water tank capacity: | 1.6L (1.4L useable) |
| Detergent tank capacity: | 0.2L |
| Cord length: | 6m |
| Weight: | 4.7kg |

Subject to technical change without notice.



Waste electrical products should not be disposed of with household waste. Please recycle where facilities exist. Check with your Local Authority or retailer for recycling advice..



Performance is everything.™

Distributed by Techtronic Industries Australia Pty. Ltd.
31 Gilby Road, Mt Waverley, VIC 3149 Australia
www.vax.com.au Careline AU: 1300 361 505
www.vax.co.nz Careline NZ: 0800 800 900