

Vax Service line: AU: 1300 361 505
NZ: 0800 800 900

Machine Overview

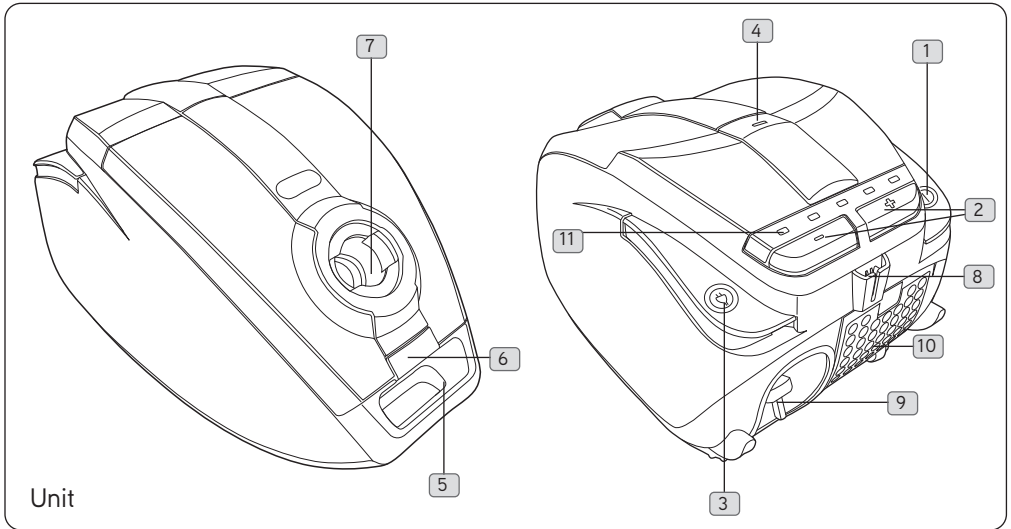

Unit

- | | | |
|----------------------|---------------------------|----------------------------|
| 1 On/off button | 5 Carry handle | 9 Plug |
| 2 Variable power | 6 Lid release button | 10 Post motor filter cover |
| 3 Cord rewind button | 7 Hose inlet | 11 Power indicator LEDs |
| 4 Bag full indicator | 8 Floor tool parking slot | |

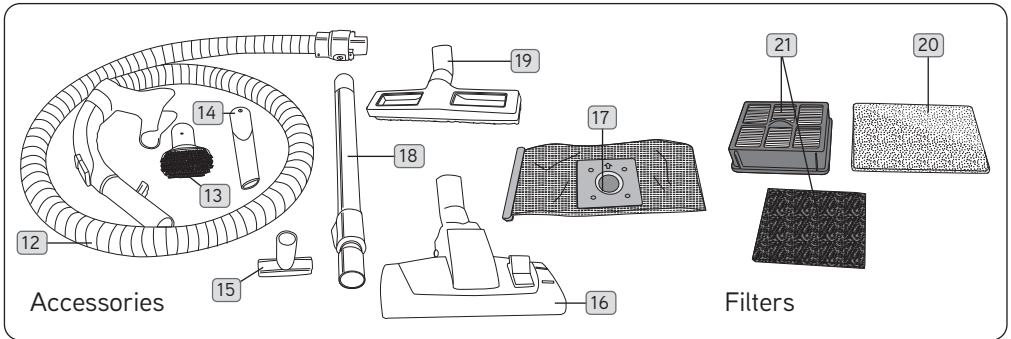

Accessories

Filters

- | | | |
|--------------------|---|---|
| 12 Hose and handle | 16 Combination floor head | 19 Hard floor tool |
| 13 Dusting brush | 17 HEPA dust bag
(1pc fitted, 2pc loose) | 20 Pre motor filters (Located inside
the dust bag cavity, behind the dust bag) |
| 14 Crevice tool | 18 Telescopic extension tube | 21 Post motor filter (Located behind
the exhaust filter cover) |
| 15 Upholstery tool | | |

General Safety Information

FOR HOUSEHOLD USE ONLY.

When using the vacuum cleaner, basic safety precautions should always be observed, including the following:

1. Only use the vacuum cleaner indoors on dry surfaces.
2. Turn off the vacuum cleaner controls before disconnecting or connecting from the mains supply.
3. Always unplug the vacuum cleaner before connecting or disconnecting the vacuum hose and accessories.
4. Children should be supervised to ensure that they do not play with the appliance.
5. This appliance is not intended for use by persons (including children) with reduced physical, sensory or mental capabilities, or lack of experience and knowledge, unless they have been given supervision or instruction concerning use of the appliance by a person responsible for their safety.
6. Use only as described in this manual. Use only Vax recommended attachments.
7. Do not use the vacuum cleaner if it has been dropped, damaged, left outdoors or dropped into water. Do not use the vacuum cleaner with a damaged cord or plug.
8. Do not pull or carry by cord. Do not use the cord as a handle, close a door on the cord or pull cord around sharp edges or corners. Do not run the vacuum cleaner over the cord. Keep the cord away from heated surfaces.
9. Do not handle the plug or vacuum cleaner with wet hands. Do not use outdoors or on wet surfaces.
10. Do not put any objects into openings. Do not use with any openings blocked and do not restrict airflow. Keep all openings free of dust, lint, hair or anything that might reduce airflow.
11. Keep hair, loose clothing, fingers and all parts of the body away from openings and moving parts.
12. Do not vacuum hot coals, cigarette butts, ash, matches or any hot, smoking or burning objects.
13. Do not vacuum flammable or combustible materials (lighter fluid, petrol, kerosene etc.) or use in the presence of explosive liquids or vapours.
14. Do not vacuum harmful or toxic material (chlorine, bleach, ammonia, drain cleaner etc.).
15. Do not vacuum plaster dust, concrete, or any other building or vitreous materials.
16. Do not vacuum hard or sharp objects such as glass, nails, screws, coins, etc.
17. Do not use without ALL of the filters and dust bag in place.
18. Take extra care when vacuuming on stairs.
19. Keep vacuuming area well lit.
20. Store the vacuum cleaner in a cool, dry area.

21. Turn off the on/off switch before unplugging the vacuum cleaner
22. Use only SAA-approved 10 amp extension cords. Non-approved cords may overheat. Care should be taken to arrange the cord so that the cord cannot be tripped over.



WARNING: Always switch off and unplug the vacuum cleaner from the electrical outlet before assembling, opening or emptying the dirt container, or before connecting/disconnecting the attachments.



CAUTION: The vacuum cleaner is a very powerful unit. Before plugging the cord into the electrical outlet, make sure the switch is in the 'off' position.



IMPORTANT: If the inlet, hose or telescopic tube is blocked, switch off the vacuum cleaner and remove the blockage(s) before re-starting the vacuum cleaner. See Maintenance: Clearing blockages.



IMPORTANT: Cleaning filters improves vacuum performance. Vax recommends that they should be checked and cleaned periodically (depending on the level of use). Make sure all filters are completely dry before inserting back into the vacuum cleaner.



NOTE: If the supply cord is damaged it must be replaced by the manufacturer, or a similarly qualified person in order to avoid a hazard, or invalidating the warranty.



IMPORTANT: Vax recommends the use of a Residual Current Device with a Residual Current Rating of 30mA or less.



IMPORTANT: The motor is equipped with a thermal cut-out. If for any reason the unit should overheat, the thermostat will automatically turn the unit off. Should this occur, unplug the vacuum cleaner from the electrical outlet and turn off the switch. Remove dirt container and empty. Clean filters. Allow the unit to cool for approximately one (1) hour. To re-start, plug into an electrical outlet and switch back on.

DAMAGE TO THE VACUUM CLEANER CAUSED AS A DIRECT RESULT OF NOT ADHERING TO THE GENERAL SAFETY INFORMATION ABOVE INVALIDATES THE WARRANTY.

This machine is intended for household use only, and NOT for commercial or industrial use.

PLEASE KEEP THESE INSTRUCTIONS FOR FURTHER USE.

Operation

Keep your Vax like new

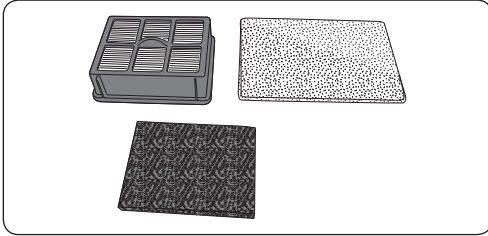

! **IMPORTANT:** The condition of the filters affects the performance of your machine. Please check and clean filters periodically (depending on the level of use). For full cleaning instructions, see Maintenance.

! **IMPORTANT:** Do not use the vacuum cleaner without all of the filters and dust bag in place.

Assembling your vacuum cleaner

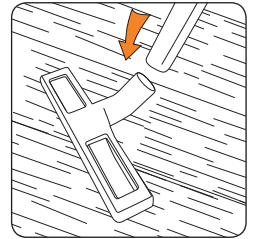
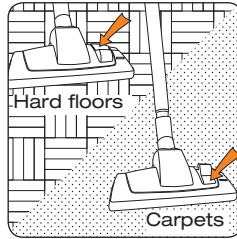
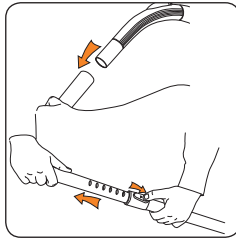
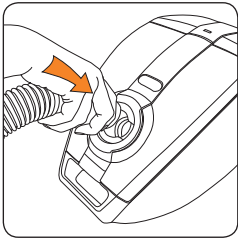

NOTE: The crevice tool, dusting brush and upholstery tool can all be attached to the telescopic tube or hose handle.

The combination floor head can be used to vacuum carpets and hard floors.

This tool is for safely cleaning hard floor surfaces such as floorboards, laminate, stone and tiled floors.

Operation

Operating the appliance

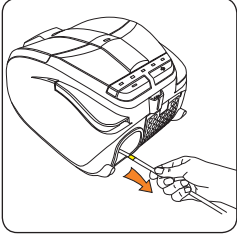

NOTE: Fully extend the power cord before every use. A yellow mark on the cord indicates the recommended cord length. Do not exceed the cord length beyond the yellow mark.

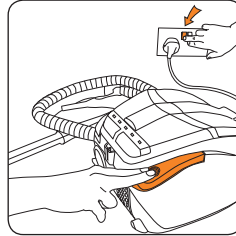

Turn the vacuum cleaner on by pressing the on/off button.

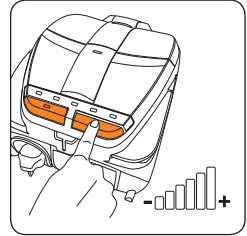

Adjust the power of the suction by pressing the variable power buttons.

Packing away and storage

NOTE: Make sure the vacuum cleaner is turned off before packing and storing away.

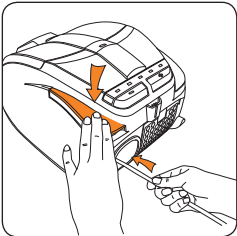

Press the cord return button.

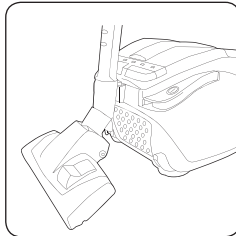

Insert the wand into the floor tool parking slot.

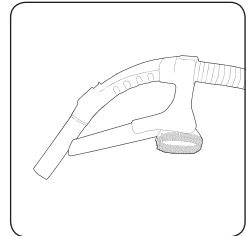

Maintenance (Keep your Vax as good as new)

Emptying the dust bag

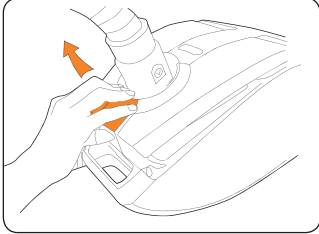

Use the lid release button to lift the vacuum cleaner cover.

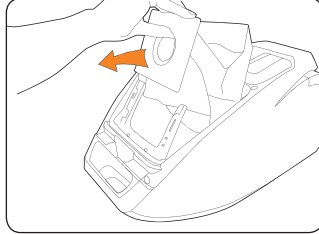

Slide the dust bag to remove from the dust bag holder.

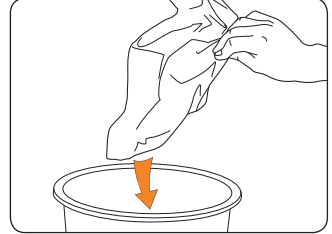

Discard dusting bag.

Cleaning the pre-motor filter



IMPORTANT: Water temperature should be at a maximum of 40° C when washing filters

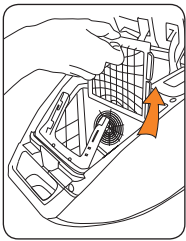

Open the front cover of the vacuum cleaner and remove the dust bag to expose the filter housing. Remove the filter and filter cover.

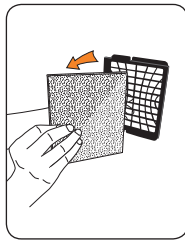

Remove foam filter from filter cover.



Tap to remove excess debris and dirt.

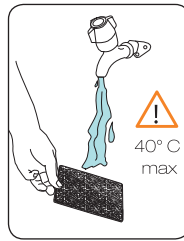

Wash under tap.

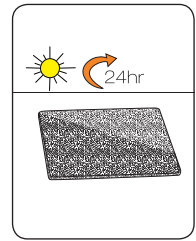

Allow to completely dry before replacing in the vacuum cleaner.

Maintenance (Keep your Vax as good as new)

Cleaning the post-motor filter

 **WARNING:** Do not wash the post-motor filter.

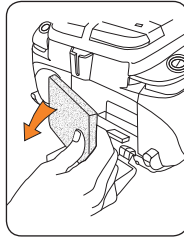
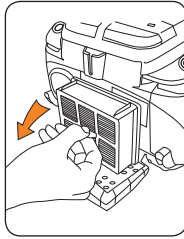
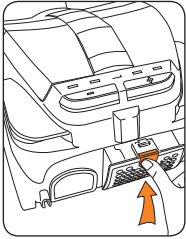

Remove post motor filter from exhaust filter cover.

Tap and remove any excess debris and dirt.

Clearing blockages

 **WARNING:** to reduce the risk of personal injury, unplug the vacuum cleaner before performing maintenance/troubleshooting checks.

Hose blockages

The flexible hose should be disconnected from the vacuum cleaner. Carefully remove any blockages found and reconnect the hose securely.

Accessory blockages

Remove accessory from the hose/handle tube. Carefully remove the blockage and return to the cleaner.

FAQ's



WARNING: To reduce the risk of personal injury, unplug the vacuum cleaner before performing maintenance/troubleshooting checks.

Problem	Solution
Is there an accessory missing?	Check the 'Parts Overview' page in this guide to make sure the part is definitely included in your unit.
Why won't the vacuum cleaner pick up?	A filter may be clogged; refer to Maintenance section.
	The dust bag is full or blocked; refer to Maintenance section.
	The dust bag may be incorrectly installed; refer to Maintenance section.
Why is dust escaping from the vacuum?	The filters may not be installed correctly; refer to Maintenance section.
	The dust bag may be incorrectly installed; remove the dust bag from the unit then re-insert it into the unit, ensuring it is pushed firmly back into place and the lid can fully close.
	The filters may be clogged; refer to Maintenance section.
Why won't the accessories pick up properly?	The accessory may be blocked; refer to Maintenance section.
Why will the vacuum cleaner not run?	It may not be plugged into the electrical outlet correctly; ensure that the plug is pushed in securely.
	The electrical outlet may not be working properly; check the fuse or breaker, or consult an electrician.
	The motor thermostat may have tripped; switch off and unplug the vacuum cleaner, and leave for one hour before switching the cleaner back on.

we're here to help

Instead of taking me back to the shop, simply call:

AU: 1300 361 505
NZ: 0800 800 900

vax.com.au

This does not affect your statutory rights

Other Information

Vax Service & Help

Vax Careline:

Australia 1300 361 505

New Zealand 0800 800 900

Monday-Friday 8.30am to 5.00pm

If you have queries or concerns about using your Vax, call the Vax Careline. Calls are charged at the standard local rate. Please make a note of the serial number and model number of the vacuum cleaner before calling.

For the nearest Service Agent, please call the Vax Customer Careline or visit vax.com.au

Technical Specification

Voltage: 220-240V ~50Hz

Wattage: 1800W

Capacity: 2.5 Litres

Filter: Pre-motor filter – (washable)
Post-motor filter – H12 HEPA (not washable, tap to clean)

Cord length: 6.5m

Weight: 6.4kg

Subject to technical change without notice.



Double
Insulated



N197



Indoor
Use



Read
Instructions



Waste electrical products should not be disposed of with household waste. Please recycle where facilities exist. Check with your Local Authority or retailer for recycling advice.





Performance is everything.™

Distributed by Techtronic Industries Pty. Ltd.
Level 1, 660 Doncaster Road, Doncaster, Australia 3108.
www.vax.com.au Service Line: AU: 1300 361 505 / NZ: 0800 800 900