



# AirMini

## User Guide

VAMC



**3 year  
warranty**

# Contents

Contents	1
Machine Overview	2
General Safety Information	3
Getting Started	5
Looking After Your Machine – Emptying and cleaning the dirt container	6
Looking After Your Machine – Filters	7
FAQs	8
Other Information	9

# Machine Overview

- 1 Handle
- 2 Dirt container lid
- 3 Inner cyclones
- 4 Dirt container
- 5 Hose connector
- 6 Main body
- 7 Cord rewind button
- 8 Wheel outer
- 9 Base
- 10 Dirt container release button
- 11 On/Off button
- 12 Wheel inner and filter housing  
(Note: Post-motor filter is housed in the right wheel)
- 13 Shroud
- 14 Cyclone separator
- 15 Upholstery tool
- 16 Dusting brush
- 17 Crevice tool
- 18 Hose
- 19 Telescopic extension tube
- 20 Combination floor head
- 21 Tool storage clip

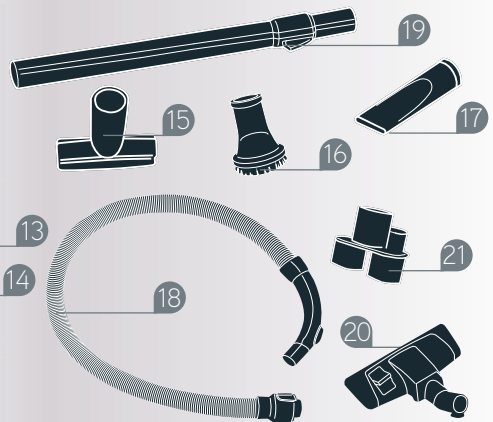

# General Safety Information

**This vacuum cleaner is intended for household use only and NOT for commercial or industrial use.**

When using the vacuum cleaner basic safety precautions should always be observed, including the following:

1. Only use the vacuum cleaner indoors on dry surfaces.
2. Turn off the on/off switch on the vacuum cleaner controls before disconnecting or connecting from the mains supply.
3. Always unplug the vacuum cleaner before connecting or disconnecting the vacuum hose and accessories.
4. Children should be supervised to ensure that they do not play with the appliance.
5. This appliance is not intended for use by children and persons with reduced physical, sensory or mental capabilities or lack of experience and knowledge, unless they have been given supervision or instruction concerning use of the appliance in a safe way and understands the hazards involved.
6. Cleaning and maintenance shall not be made by children.
7. The appliance should only be used as described in the quick start guide and in the full user guide.
8. Only Vax recommended attachments should be used with this appliance.
9. Do not use this vacuum cleaner if it has been dropped, damaged, left outdoors or dropped into water. Do not use this vacuum cleaner with a damaged cord or plug.
10. Do not pull or carry this appliance by the cord. Do not use the cord as a handle, close a door on the cord or pull the cord around sharp edges or corners. Do not run the vacuum cleaner over the cord. Keep the cord away from heated surfaces.
11. Do not handle the plug or the vacuum cleaner with wet hands.
12. Keep hair, loose clothing, fingers and all parts of the body away from openings and moving parts.
13. Do not pick up any hot coals, ash, cigarette butts, matches or any hot, smoking or burning objects.
14. Do not pick up any flammable or combustible materials (lighter fluid, petrol, kerosene etc.) or use in the presence of explosive liquids or vapours.
15. Do not vacuum harmful or toxic material (chlorine, bleach, ammonia, drain cleaner etc.).
16. Do not vacuum hard or sharp objects such as glass, nails, screws, coins etc.
17. Do not vacuum plaster dust, concrete dust or any other building or vitreous materials.
18. Do not vacuum baking soda or any other powder-based carpet refresher or deodoriser.
19. Store the vacuum cleaner in a cool, dry area.
20. Use only SAA approved 10amp extension cords. Non-approved cords may overheat. Care should be taken to arrange the cord so that the cord cannot be tripped over.
21. Do not put any objects into openings. Do not use with any openings blocked and do not restrict airflow. Keep all openings free of dust, lint, hair or anything that might reduce airflow.
22. Do not use the vacuum cleaner with blocked filters and without all of the filters in place.
23. Take extra care when positioning the vacuum cleaner on the stairs.
24. Keep vacuuming area well lit.

# General Safety Information

- WARNING:** Always switch off and unplug the vacuum cleaner from the electrical socket before assembling, opening or emptying the dirt container, or before connecting/disconnecting the attachments.
- CAUTION:** The vacuum cleaner is a very powerful unit. Before plugging the cord into the electrical socket, make sure the switch is in the 'off' position.
- IMPORTANT:** If the inlet, hose or telescopic tube is blocked, switch off the vacuum cleaner and remove the blockage(s) before re-starting the vacuum cleaner.
- IMPORTANT:** Vax recommends the use of Residual Current Device Rating of 30mA or less.
- IMPORTANT:** It is very important that filters are kept clean to obtain maximum performance from your vacuum cleaner. Not cleaning and not replacing your filters regularly can reduce the suction power and cause overheating and permanent damage to the vacuum cleaner.
- NOTE:** If the supply cord is damaged it must be replaced by the manufacturer, or a similarly qualified person in order to avoid hazard, or invalidating the warranty.
- IMPORTANT:** The motor is equipped with a thermal cut-out. If for any reason the unit should overheat (eg. from blocked nozzles, a full dust container or unclean filters), the thermostat will automatically turn off the switch. Should this occur, unplug the vacuum cleaner from the electrical socket and turn off the switch. Remove dirt container and empty. Clean filters. Allow the unit to cool for approximately one (1) hour. To re-start, plug into an electrical socket and switch back on.

**DAMAGE TO THE VACUUM CLEANER CAUSED AS A DIRECT RESULT OF NOT ADHERING TO THE GENERAL SAFETY INFORMATION AND THE INSTRUCTIONS IN THIS USER GUIDE INVALIDATES THE WARRANTY**

PLEASE KEEP THESE INSTRUCTIONS FOR FUTURE REFERENCE

# Getting Started

## PLEASE READ SAFETY INFORMATION BEFORE USE (pages 3-4)

Before plugging the cord into the electrical outlet, make sure the switch is in the 'off' position. Hold the vacuum cleaner firmly when starting and in use.

## Assembling your cylinder

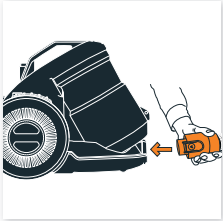

Insert the end of the hose into the unit. Ensure the hose has clicked into place.

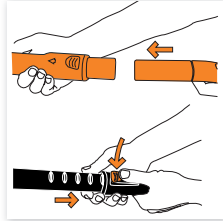

Slot the metal telescopic extension tube and hose handle together. All accessories can be fitted to the end of the metal telescopic extension tube.

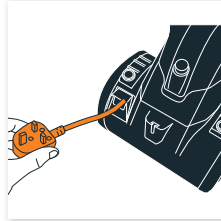

Fully unwind the power cord. A yellow mark on the cord indicates the recommended cord length. Do not exceed the cord beyond the yellow mark.

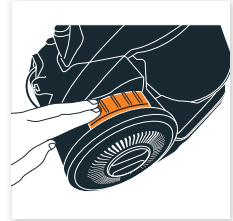

Plug in and switch the unit on by pressing the power button.

## How to use

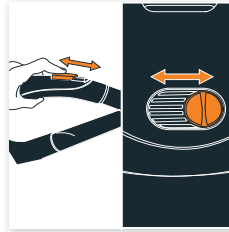

To vary the suction power open/close the sliders on the hose handle.

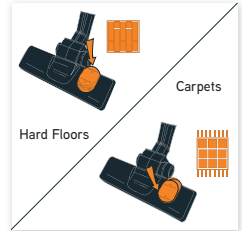

For use on carpets click rocker switch forward. For use on hard floors click rocker switch back.

## Storage

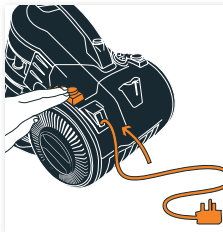

Cable rewind button is located at the rear of the machine. After unplugging press the cable rewind until the cord is fully retracted.

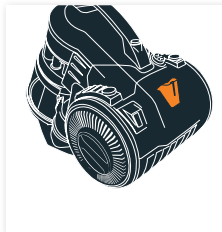

For convenience there is a parking slot located at the rear of the vacuum cleaner where the floor head and tubes can be attached for storage and carrying

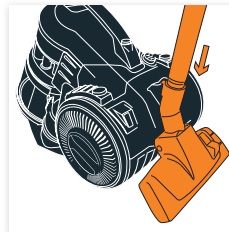

# Looking After Your Machine

**WARNING:** Always switch off and unplug the vacuum cleaner from the electrical socket before assembling, opening or emptying the dirt container, or before connecting/disconnecting the attachments.

**IMPORTANT:** Filters need to be cleaned **every time you empty the dirt container for best cleaning results.** Do not use your vacuum cleaner with blocked filters and without all of the filters in place.

**IMPORTANT:** The motor is equipped with a thermal cut-out. If for any reason the unit should overheat, the thermostat will automatically turn the unit off.

## Emptying and cleaning the dirt container

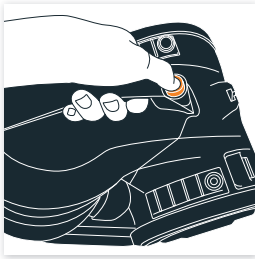

Press dirt container release button to remove the dirt container.



Hold dirt container over a bin and press dirt release button to open, allowing dirt to fall out.



To remove the inner shroud, hold the container and rotate the shroud clockwise.

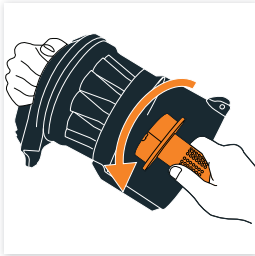

Hold the container and turn the cyclone separator anti-clockwise.



Tap to remove dirt.

# Looking After Your Machine

## Cleaning the pre-motor filter

Tap excess dirt from the filter rinse under a tap and leave to dry for 24 hours.

**WARNING:** Water temperature should not exceed 40°C when washing pre-motor filter.

**WARNING:** Ensure filters are completely dry before inserting back into the vacuum cleaner.



Hold the dirt container and twist the lid anti-clockwise.

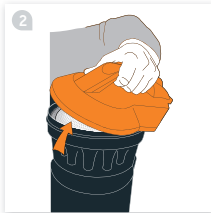

Lift the lid to reveal the pre-motor filter.

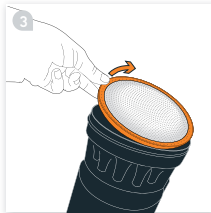

Lift out the pre-motor filter.

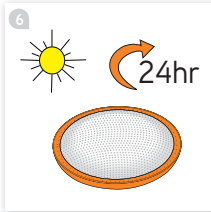

## Cleaning the HEPA media post-motor filter

**WARNING:** Do not wash. 

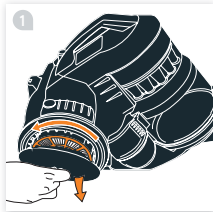

Post-motor filter is located in the right side wheel. Hold the centre of the wheel and twist wheel cover anti-clockwise.

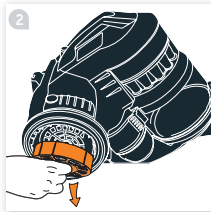

With the wheel cover off the post-motor filter is easily removed.

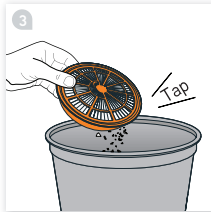

Tap all excess dirt off the filter.



**Warning: To reduce the risk of personal injury, unplug the vacuum cleaner before performing maintenance/troubleshooting checks.**

#### Is there an accessory missing?

- Check the 'Getting Started' page in this guide to make sure that the part is definitely included in your unit.
- If it is missing, we're here to help. Simply call us on **AU 1300 361 505 / NZ 0800 800 900**

#### Why won't the vacuum cleaner pick up?

- The filters may need cleaning, please refer to the 'Looking After Your Machine – Cleaning the filters' page of this user guide (p7)
- The separator may be clogged, please refer to the 'Looking After Your Machine – Emptying and cleaning the dirt container' page of this user guide (p6)
- There may be a blockage in the hose, please check the hose and remove the blockage
- The dirt container may be full or blocked, please refer to the 'Looking After Your Machine – Emptying and cleaning dirt container' page of this user guide (p6)
- The dirt container may be incorrectly installed, please ensure the dirt container is locked in place

#### What do I do if an accessory/the unit becomes damaged or broken?

- Please check if the damage is with the accessory or the unit. To do this, firstly remove the accessory from the unit and check if there is suction from the hose. If there is suction from the hose this confirms that the damage is with the accessory. Call us on **AU 1300 361 505 / NZ 0800 800 900** for a replacement.
- If having done the above checks, checked the hose for blockages and cleaned the filters there is still no suction/limited suction from the hose, please call our Vax Careline **AU 1300 361 505 / NZ 0800 800 900**

#### Why is dust escaping from the vacuum?

- The filters may not be installed correctly, please refer to the 'Looking After Your Machine – Cleaning the filters' page of the user guide (p7)
- The dirt container may be full or blocked, please refer to the 'Looking After Your Machine – Emptying and cleaning dirt container' page of this user guide (p6)
- The filters may need cleaning, please refer to the 'Looking After Your Machine – Cleaning the filters' page of this user guide (p7)
- There may be a blockage in the hose, please check the hose and remove the blockage

#### Why does my vacuum cleaner have no power?

- It may not be plugged into the electrical socket correctly. Ensure that the plug is pushed into the electrical socket securely
- The electrical socket may not be working. Check the fuse or breaker and consult an electrician
- The motor thermostat may have tripped. Switch off and unplug the vacuum cleaner. Check the unit for blockages, clean the filters – please refer to the 'Looking After Your Machine – Cleaning the filters' page of this user guide (p7) and clean the separator – please refer to the 'Looking After Your Machine – Emptying and cleaning dirt container' page of this user guide (p6). Leave the vacuum cleaner for 24 hours before switching the vacuum cleaner back on

#### Why does the vacuum cleaner cut out?

- The motor is equipped with a thermal cut-out. If for any reason the unit should overheat, the thermostat will automatically turn the unit off. Should this occur, unplug the vacuum cleaner from the electrical socket and turn off the switch. Remove and empty the dirt container. Check the hose for blockages. Clean the filters. Allow the unit to cool for approximately 1 hour (if you have cleaned the filters you will need to wait 24 hours for the filters to dry before putting them back in the machine)

#### What do I do if the unit becomes damaged or broken?

- We're here to help. Simply call **AU 1300 361 505 / NZ 0800 800 900** or visit [vax.com.au](http://vax.com.au) / [vax.co.nz](http://vax.co.nz)

# Other Information

## Vax Service & Help

Vax Careline:

Australia 1300 361 505  
New Zealand 0800 800 900

Monday-Friday 8.30am to 5.00pm

If you have queries or concerns about using your Vax, call the Vax Careline. Calls are charged at the standard local rate. Please make a note of the serial number and model number of the vacuum cleaner before calling.

For the nearest Service Agent, please call the Vax Customer Careline or visit [vax.com.au](http://vax.com.au) / [vax.co.nz](http://vax.co.nz)

## Technical Specification

Wattage: 1600W

Air Wattage: 280W

Voltage: 220-240V ~50Hz

Filters: Pre-motor: Washable  
Post-motor: HEPA Media Filter (not washable, tap to clean)

Dust Capacity: 2L

Hose Length: 2m

Cord Length: 6m

Weight: 4.9kg (Cylinder weight)

Subject to technical change without notice.



Double  
Insulated



Indoor  
Use



Read  
Instructions





Distributed by Techtronic Industries Australia Pty. Ltd.  
Level 1, 660 Doncaster Road, Doncaster, Australia 3108.  
Service Line: AU: 1300 361 505 / NZ: 0800 800 900