



we  clean

# User Guide

Vax Careline: AU: 1300 361 505  
NZ: 0800 800 900

## Carpet Washer

*Rapide*  
CARPET WASHER *Spring Clean*

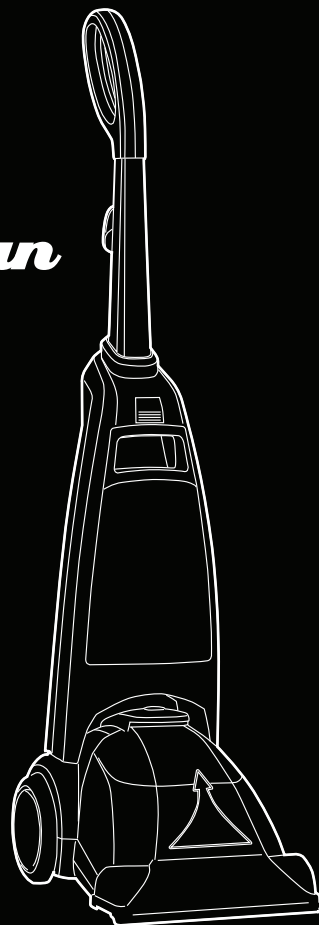

## Get Cleaning...

What's your Vax's model number?

V C W R S 7 0 0

What's your serial number? (Located on the base of the machine)

-       -   -   -   -

Note these down in case you need them in future. Please keep instructions for further use.

[www.vax.com.au](http://www.vax.com.au)

VCWRS700

# Machine Overview

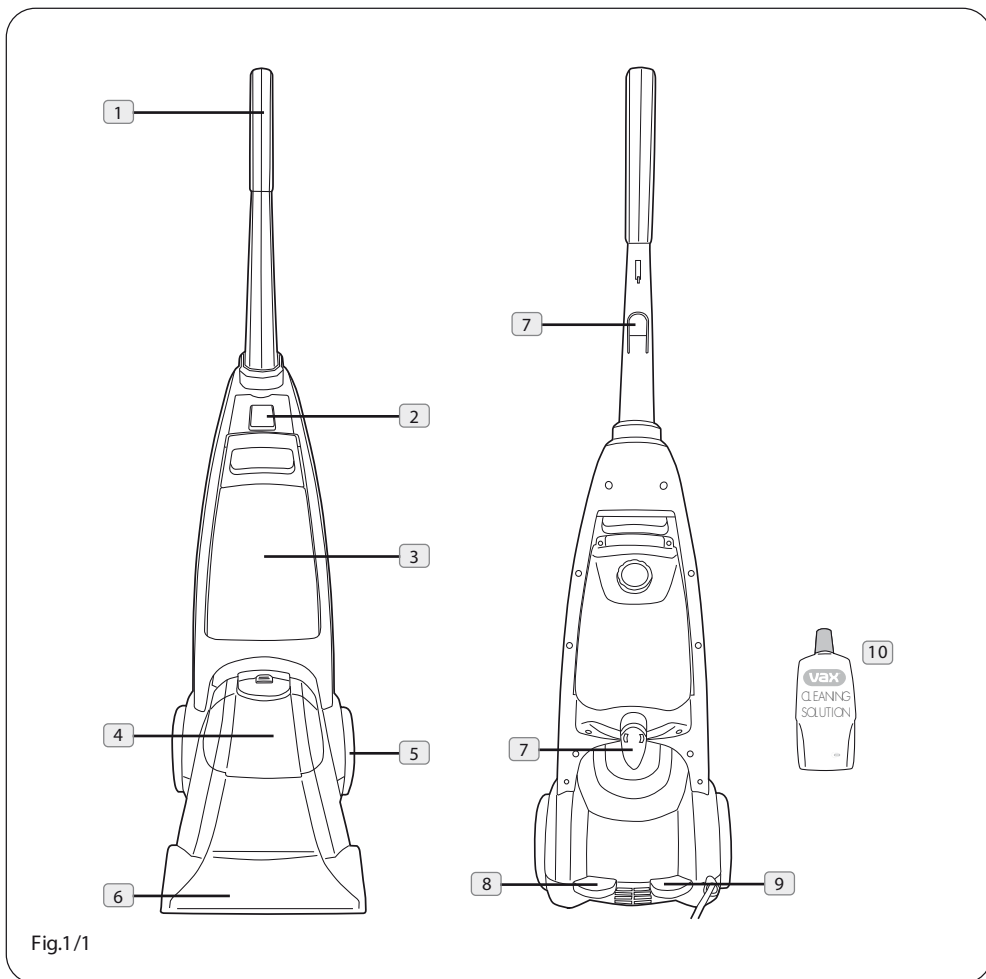

Fig.1/1

- 1 Handle
- 2 Clean water tank release button
- 3 Clean water tank
- 4 Dirty water tank lid
- 5 Wheels
- 6 Suction channel

- 7 Cord hooks
- 8 On/off switch
- 9 Handle release pedal
- 10 Vax Carpet Cleaning Solution

# General Safety Information

## FOR HOUSEHOLD USE ONLY.

When using the carpet washer, basic safety precautions should always be observed, including the following:

1. Do not leave the carpet washer unattended when plugged in. Unplug it from socket when not in use.
2. To prevent electric shock do not use outdoors.
3. Not to be used as a toy. Children should be supervised to ensure that they do not play with the appliance.
4. This appliance is not intended for use by persons (including children) with reduced physical, sensory or mental capabilities, or lack of experience and knowledge, unless they have been given supervision or instruction concerning the use of the appliance by a person responsible for their safety.
5. Use only as described in this manual.
6. Do not use the carpet washer if it has been dropped, damaged, left outdoors or dropped into water. Do not use the carpet washer with a damaged cord or plug. If the supply cord is damaged, it must be replaced by the manufacturer or a recommended Service Agent to avoid hazard and invalidating the guarantee.
7. Do not pull or carry by cord/hose. Do not use the cord/hose as a handle, close a door on the cord/hose or pull cord/hose around sharp edges or corners. Do not run the carpet washer over the cord/hose. Keep the cord away from heated surfaces.
8. Do not unplug by pulling on the cord.
9. Do not handle the plug or carpet washer with wet hands.
10. Do not put any objects into openings or operate with openings blocked, keep them free of anything that may reduce airflow.
11. Keep hair, loose clothing, fingers and all parts of the body away from openings and moving parts.
12. Do not use the carpet washer on any glowing, burning or smoking particles.
13. Do not use without the solution tank and dirty water tank in place.
14. Turn off all controls before unplugging.
15. Do not use to pick up flammable or combustible liquids such as petrol, or use in areas where they may be present.

16. Keep the unit on the floor.
17. Do not attempt to remove blockages with sharp objects as they may cause damage.
18. Store indoors put away after use to prevent tripping accidents.
19. Using improper voltage may result in damage to the motor and possible injury to the user. The correct voltage is listed on the rating label.
20. A hazard may occur if the carpet washer runs over the power supply cord.
21. To prevent dirty water from running into the motor, do not hold the appliance upside-down or lay on its side. Use appliance in normal cleaning position.
22. Use extra care when cleaning on stairs.
23. Do not carry appliance while motor is running.
24. Use only SAA approved 10amp extension cords. Non-approved cords may overheat. Care should be taken to arrange the cord so that the cord cannot be tripped over.

 **WARNING:** Always switch off and unplug your machine from the electrical outlet before filling and emptying the clean water tank, emptying the dirty water tank, before assembling, opening, before connecting/disconnecting the attachments, or carrying out maintenance or troubleshooting checks and storage.

 **NOTE:** Carpets should be dry vacuumed thoroughly before washing.

 **IMPORTANT:** If the hose or tools are blocked, switch off and unplug the carpet washer and remove the blockage(s) before re-starting your machine. See maintenance.

 **IMPORTANT:** Cleaning filters maintains cleaning performance. Vax recommends that your filters should be checked and cleaned periodically. If your filters are washable make sure they are completely dry before inserting back into the machine.

**This machine is intended for household use only, and NOT for commercial or industrial use.**

**PLEASE KEEP THESE INSTRUCTIONS FOR FURTHER USE.**

# Operation

## Assembly: Putting your cleaner together

Insert middle frame to machine base (Fig 3/1).

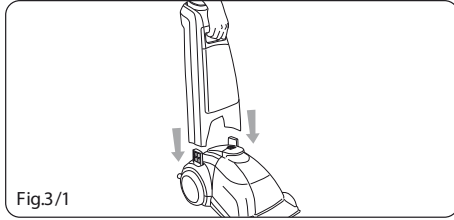

Fig.3/1

Insert one screw on either side of middle frame to secure (Fig 3/2).

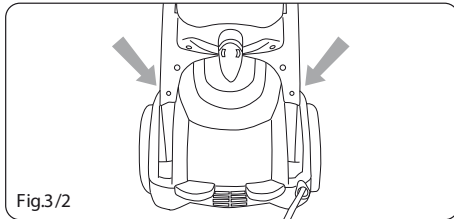

Fig.3/2

Slide the upper handle down onto the unit. The handle will click and lock in place. Run the mains wire above the upper cord hook and secure with the cord clip (Fig 3/3).

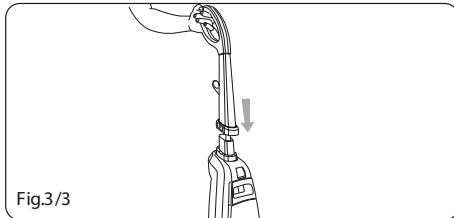

Fig.3/3

Insert locking pins into either side of handle (Fig 3/4).  
Screw locking pins into handle (Fig 3/5).

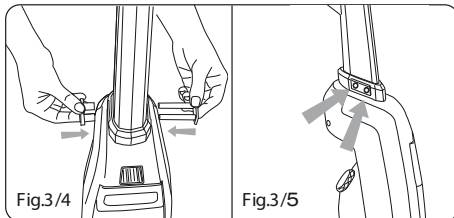

Fig.3/4

Fig.3/5

## Operation

**! IMPORTANT:** Turn off when emptying and filling the tanks and performing any maintenance.

Grasp the solution reservoir under the handle and press the handle release lever in (Fig 4/1).

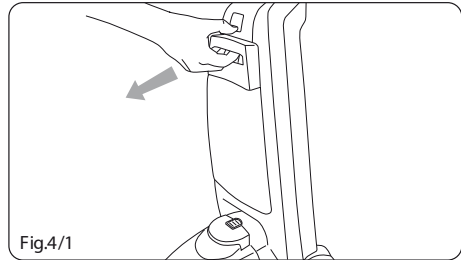

Fig.4/1

Tilt the solution reservoir away from the cleaner and remove (Fig 4/2).

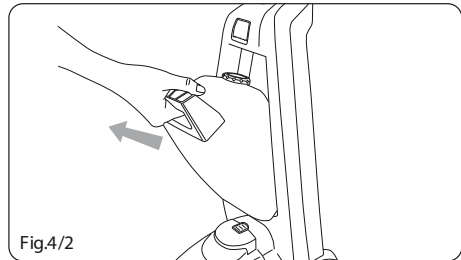

Fig.4/2

Unscrew the cap from the back of the solution reservoir (Fig 4/3).

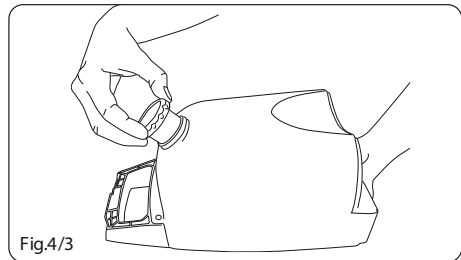

Fig.4/3

Pour the correct amount of Vax Solution as directed on the solution label into the clean water tank.

# Operation

**!** **IMPORTANT: Maximum water temperature 50°C**

Fill the remaining space in the solution reservoir with warm tap water. Replace the measuring cap (Fig 4/4).

**NOTE:** use only Vax Solution, using other cleaning solutions may cause excessive foaming. This may cause the float to shut off the cleaner prematurely. Using other cleaning solutions will invalidate your warranty.

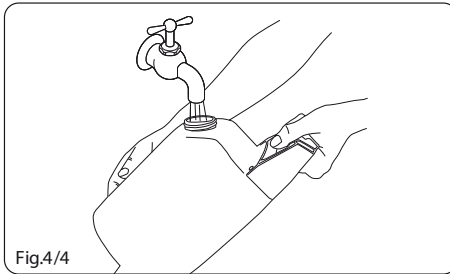

Place the bottom of the solution reservoir into the cleaner and push into place. There will be an audible click when the reservoir is in the correct position (Fig 4/5).

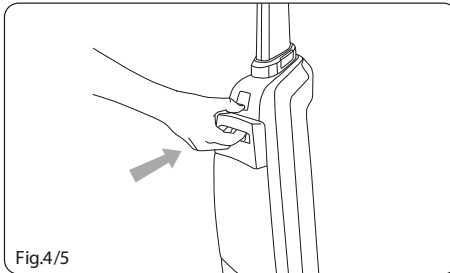

Plug the cord into a mains electricity socket.  
Turn the power switch on (Fig 4/6).

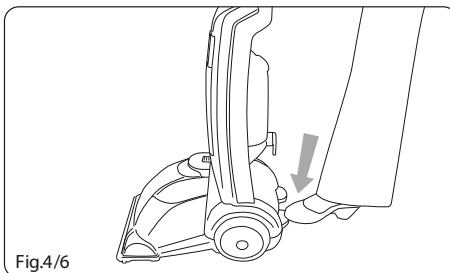

The switch is located on the back of the cleaner, next to the handle release.

The power switch controls the vacuum motor. Press on the handle release pedal and pull the cleaner back into a reclined position (Fig 4/7).

**!** **IMPORTANT: Never leave the cleaner unattended with the power on.**

**NOTE:** Vacuum carpets thoroughly with dry vacuum cleaner before washing.

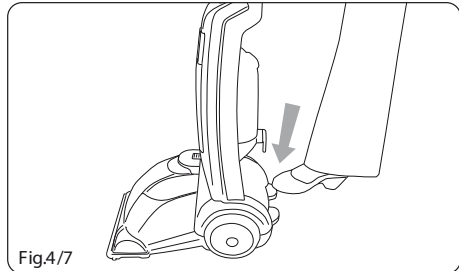

Whilst depressing solution spray trigger, push carpet washer in a forwards motion. Release trigger and pull unit backwards in same path to remove dirty water and solution from the carpet. (Fig 4/8).

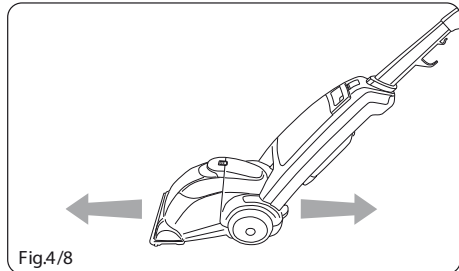

Repeat if necessary, when the dirty water reaches the max fill line on the dirty water tank empty the tank.

# Maintenance (Keep your Vax as good as new)

## Emptying the dirty water tank

**NOTE:** The float in your Rapide is located in the lid of the dirty water tank. It will shut off the suction when the dirty water tank is full. For best results use a smooth steady motion keeping the nozzle flat against the carpet.

Tipping the cleaner and breaking the seal of the nozzle against the carpet will cause the float to rise cutting off suction. Once the float is activated, empty the dirty water tank. If the tank does not appear full turn off the power switch and wait for the float to settle. For best results use only Vax Solution.

You will hear a change in motor pitch when the tank is full and needs emptying.

**⚠ IMPORTANT:** Unplug your cleaner before emptying the dirty water tank.

Grasp the top of the dirty water tank handle and press the release latch. Pull to remove from the base, take care to ensure that no dirty water leaks from the front (Fig 4/10).

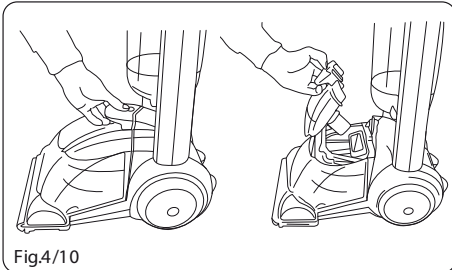

Fig.4/10

Remove dirty water tank (Fig 4/11).

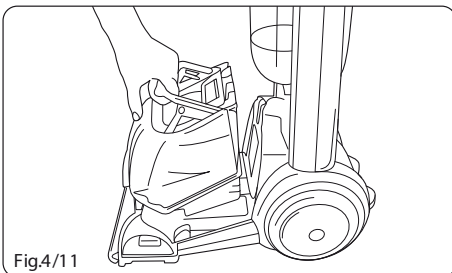

Fig.4/11

To empty the water tank grasp the handle with one hand and nozzle with the other and empty into the sink (Fig 4/13).

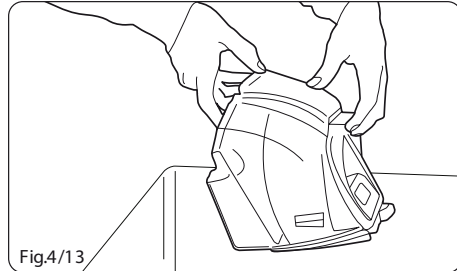

Fig.4/13

## Cleaning the dirty water tank

Rinse the dirty water tank and top thoroughly, with warm water (Fig 4/14).

You should allow them to dry fully before replacing them on your cleaner to prevent mildew.

Do not use any chemicals in the cleaning process.

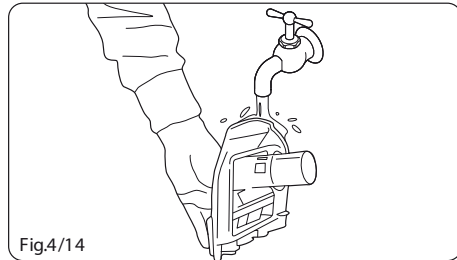

Fig.4/14

## Replacing the dirty water tank

Lift the front of the carpet cleaner base off the carpet with one hand.

Grasp the handle and hook the front of the dirty water tank into the base, making sure that the front of the dirty water tank is resting on the base.

Failure to install the dirty water tank correctly will result in poor dirty water pick up (Fig 4/15).

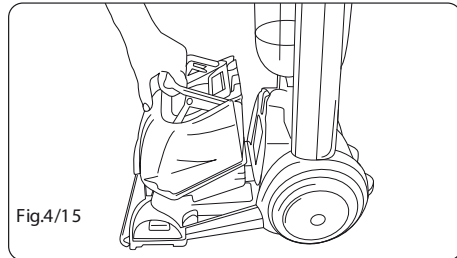

Fig.4/15

# Maintenance (Keep your Vax as good as new)

While making sure the dirty water tank is resting on the base, place the rear of the tank into the base of the cleaner, push down on the handle until it latches.

Replace top of dirty water tank by pressing it into place (Fig 4/16).

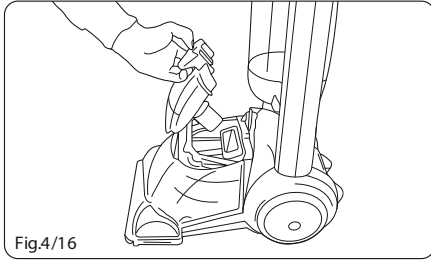

Fig.4/16

## Brush removal and replacement

**NOTE:** The plug must be removed from socket outlet before cleaning or maintaining the appliance.

Switch off and unplug carpet washer, then remove the water tank.

Flip the cleaner on its side to expose the nozzle base.

Lift out the floating brush bar by pressing the two latches and pulling it gently (Fig 5/1).

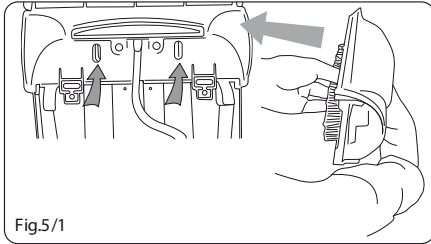

Fig.5/1

Replace floating brushbar (Fig 5/2).

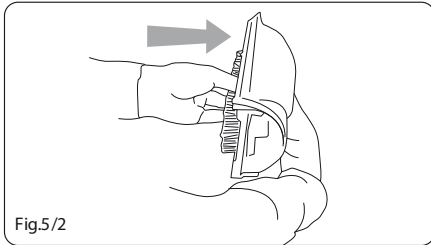

Fig.5/2

## Cleaning the tank filter

**!** **IMPORTANT:** Do not use any detergents or boiling water to wash the filters. Vax recommends checking the filters everytime the dirty water tank is emptied.

**!** **NOTE:** All filters must be in place before using your machine.

- 1 Remove the dirty water tank from the unit.
- 2 Remove the filter cover from the back of the tank.

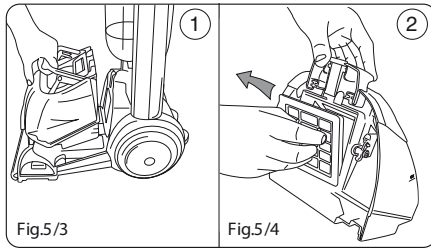

Fig.5/3

Fig.5/4

- 3 Separate the filter from the filter cover.

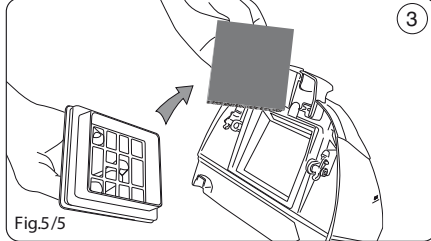

Fig.5/5

The filter can be rinsed in warm water (max. 40°C)

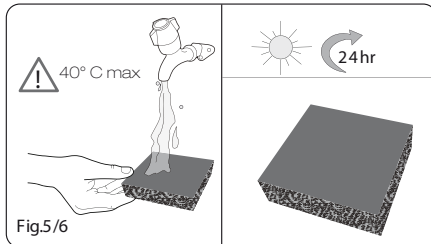

Fig.5/6

**!** **IMPORTANT:** Ensure filter is fully dry (allow 24hrs) before replacing back into the machine.

# FAQs



**WARNING:** To reduce the risk of personal injury, unplug the carpet washer before performing maintenance/troubleshooting checks.

**PROBLEM: The cleaner won't run.**

Cause: Not properly plugged into electrical outlet.

Solution: Plug in firmly.

Cause: No electricity in electrical outlet.

Solution: Check fuse or breaker.

Cause: On/off switch not turned on.

Solution: Push on/off switch to 'on'.

Cause: Blown fuse/tripped breaker.

Solution: Reset circuit breaker or replace fuse.

**PROBLEM: Cleaner won't pick up/loss of suction.**

Cause: Dirty water tank is full.

Solution: Switch off and unplug cleaner. Empty dirty water tank as shown on page 6.

Cause: Dirty water tank not installed correctly.

Solution: Refer to page 6 for fitting information.

Cause: Obstruction in hose/nozzle.

Solution: Remove hose and clear obstruction.

**PROBLEM: Liquid escaping from the carpet washer.**

Cause: Dirty water tank is full.

Solution: Switch off and unplug cleaner. Empty dirty water tank as shown on page 6.

Cause: Dirty water tank not installed correctly.

Solution: Refer to page 6 for fitting information.

Cause: Solution tank not installed correctly.

Solution: Make sure the tank is securely locked in place

**PROBLEM: Clean solution won't dispense.**

Cause: Solution tank not installed correctly.

Solution: Make sure the tank is securely locked in place.

Cause: Solution tank empty.

Solution: Refill tank. Refer to page 4/5 for instructions.

Cause: Handle not fitted correctly.

Solution: Ensure handle is fitted correctly.



we  to help

Don't take me back to the shop, simply call us

AU: 1300 361 505  
NZ: 0800 800 900 [www.vax.com.au](http://www.vax.com.au)

This does not affect your statutory rights

# Other Information

## Vax Service & Help

Vax Careline:

(AU) 1300 361 505

(NZ) 0800 800 900

Monday-Friday 8.30am to 5.00pm

If you have queries or concerns about using your Vax, call the Vax Careline. Calls are charged at the standard local rate. Please make a note of the serial number and model number of the vacuum cleaner before calling. For the nearest Service Agent, please call the Vax Customer Careline or visit [www.vax.com.au](http://www.vax.com.au).

## Technical Specification

Voltage: 220-240V ~50Hz

Wattage: 700 W

Capacity: Clean water tank 2.5L

Dirty water tank 1.5L

Cord length: 6m

Weight: 6.2kg

Subject to technical change without notice.

Manufacturer/EEC importer: Vax Limited, hereby on our own responsibility, declare that the Rapide Ultra series is manufactured in compliance with the following Directives:

**Safety:** 2006/95/EC Low Voltage Directive

**EMC:** 2004/108/EC Electromagnetic Compatibility Directive



Waste electrical products should not be disposed of with household waste. Please recycle where facilities exist. Check with your Local Authority or retailer for recycling advice.

# Notes

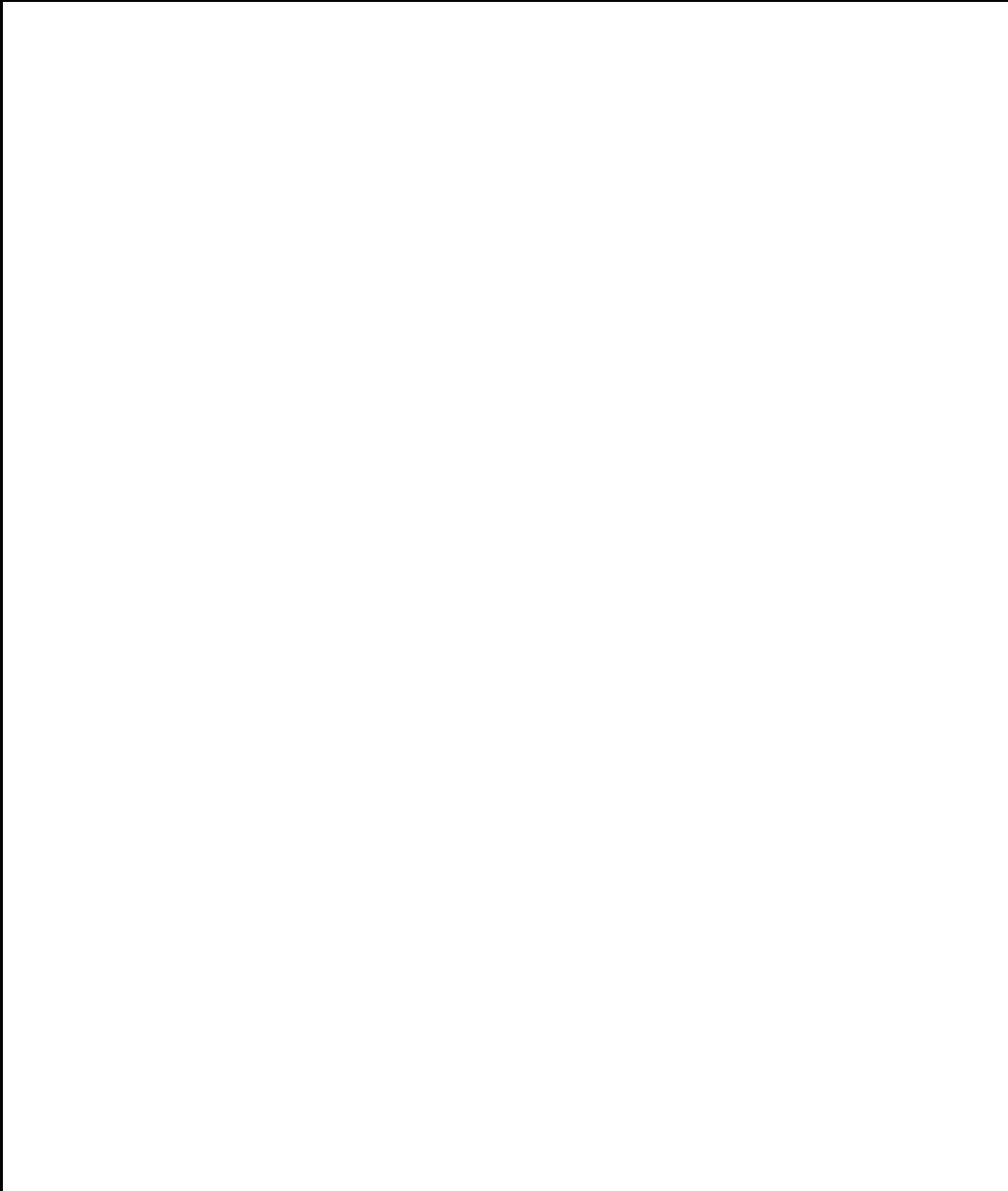



we  clean

Distributed by Techtronic Industries Pty. Ltd.  
Level 1, 660 Doncaster Rd, Doncaster, Australia 3108.  
[www.vax.com.au](http://www.vax.com.au). Service Line: AU: 1300 361 505 / NZ: 0800 800 900