

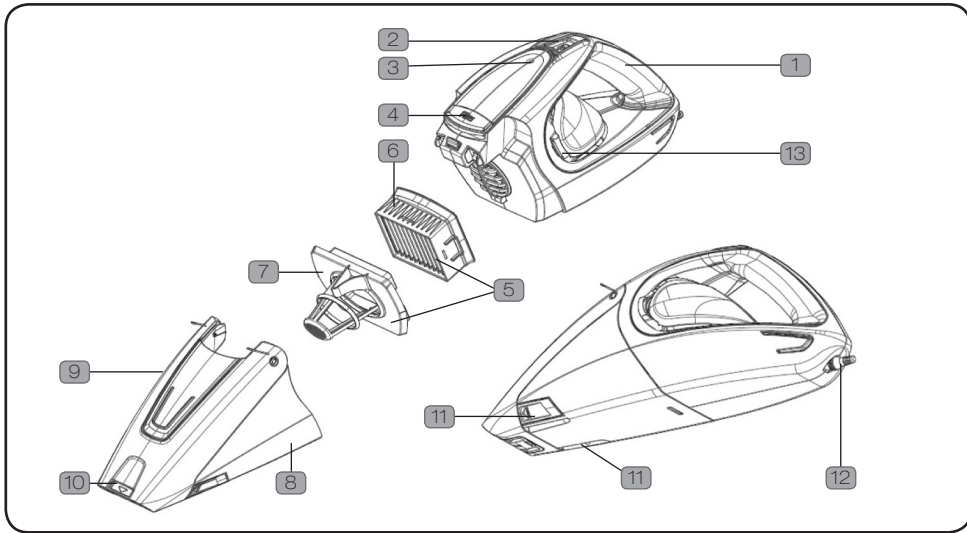

# Machine Overview



- |                        |                               |   |
|------------------------|-------------------------------|---|
| 1 Handle               | 6 Pleated filter              | 11 Gator™ Series Dirt cup release buttons (2) |
| 2 Power On/ Off button | 7 Pre-screen                  | 12 Charging port                              |
| 3 Charging LED         | 8 Gator™ Series Dirt cup      | 13 Exhaust vent                               |
| 4 Filter access button | 9 Gator™ Series Dirt cup door | 14 Charger                                    |
| 5 Filter assembly      | 10 Inbuilt crevice tool       |   |

## Accessories



# General Safety Information

## FOR HOUSEHOLD USE ONLY.

When using the vacuum cleaner, basic safety precautions should always be observed, including the following:

1. Do not charge the unit outdoors.
2. Turn off the handheld before connecting or disconnecting from the mains supply.
3. Children should be supervised to ensure that they do not play with the appliance.
4. This appliance is not intended for use by persons (including children) with reduced physical, sensory or mental capabilities, or lack of experience and knowledge, unless they have been given supervision or instruction concerning use of the appliance by person responsible for their safety.
5. Use only as described in this manual. Use only the manufacturer's recommended attachments.
6. Do not use the vacuum cleaner if it has been dropped, damaged, left outdoors or dropped into water. Do not use the vacuum cleaner with a damaged cord or plug. If the supply cord is damaged, it must be replaced by the manufacturer, its service agent or similarly qualified persons in order to avoid a hazard.
7. Do not abuse the cord. Keep the cord away from heated surface. Do not pull the cord around sharp edges or corners. Do not close the cord in a door.
8. Do not handle the plug or appliance with wet hands.
9. This product contains rechargeable Nickel Cadmium batteries. Do not throw batteries into fire or expose them to high temperatures, as they may burst.
10. Do not use with any opening blocked; keep free of dust, lint, hair, and anything that may reduce airflow.
11. Keep hair, loose clothing, fingers and all parts of the body away from openings and moving parts.
12. Do not pick up hot coals, cigarette butts, matches or anything hot, smoking or burning objects.
13. Do not pick up flammable or combustible materials (lighter fluid, petrol, kerosene, etc) or use in the presence of explosive liquids or vapour.
14. Do not vacuum up harmful or toxic material (chlorine bleach, ammonia, drain cleaner, etc).
15. Do not use without the filter in place.
16. Do not vacuum up hard or sharp objects such as glass, nails, screws, coins, etc.

17. Turn off all controls before unplugging.
18. Take extra care when cleaning on stairs
19. Store the appliance indoors in a cool, dry area.
20. Use only the charger supplied by the manufacturer to recharge the battery.



**IMPORTANT:** For dry debris use only



**WARNING:** Always switch off and unplug the handheld from the electrical outlet before assembling, opening or emptying the dirt container, or before connecting/disconnecting the attachments or performing any maintenance.



**IMPORTANT:** Remove the battery from the appliance before recycling. For further information please contact your local waste management centre.

**This handheld is intended for household use only and NOT for commercial or industrial use.**

**PLEASE KEEP INSTRUCTIONS FOR FURTHER USE.**

# Operation

## Charging

**NOTE:** Use only the charger supplied by the manufacturer to recharge.

**!** **IMPORTANT:** Before first use, charge your unit for at least 16 hours.

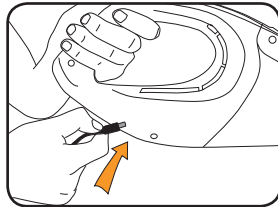

Power switch must be in the OFF position.

The indicator light will come on to indicate that the appliance is charging. The light will not change when the unit is charged.

It is normal for the charger to become warm to touch when charging.

If the operating time gets shorter after repeated use, let the unit run until it slows down. Recharge for 16 hours and repeat monthly for best results..

## Operating the appliance

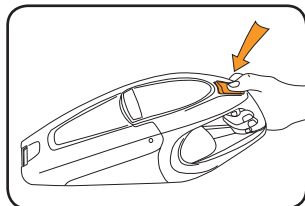

On/ Off Switch



## Tools

**NOTE:** Crevice tool is retractable

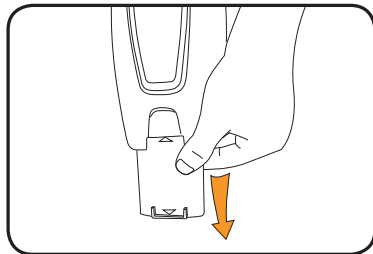

A crevice tool is built-in to the nozzle and can be extended by pulling the extension piece until it locks into position.

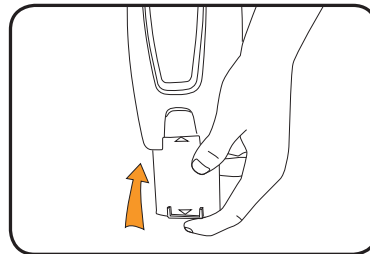

The extension can be retracted by depressing the arrow button near the front of the nozzle and pushing the extension back into the nozzle.

# Operation

## Emptying the dirt container

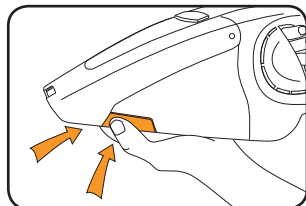

To open, press both buttons either side of the dirt container simultaneously.

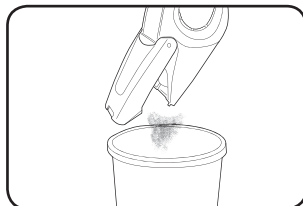
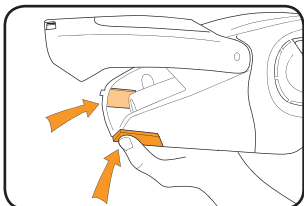

Empty over a bin.

# Maintenance

## Dirt container and filter maintenance

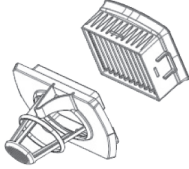

**!** **IMPORTANT:** The condition of the filter affects the performance of your machine. Please check and clean the filter periodically (depending on the level of use).

**!** **IMPORTANT:** Do not use the handheld without the filter in place

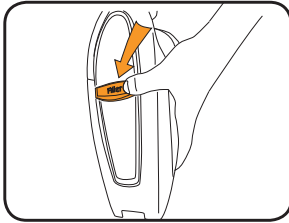

Depress the dirt container removal button and pull nozzle away from unit.

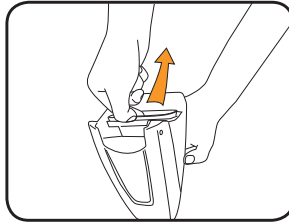

Hold nozzle over a bin. Grasp filter gently and pull out.

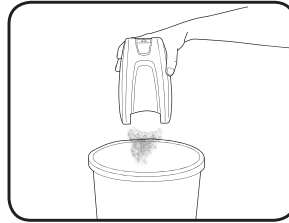

Shake excess dirt from dirt container. Tap against bin for better result.

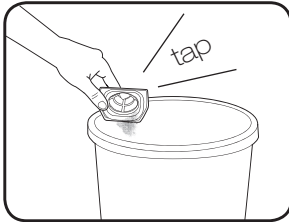

Tap filter against bin.

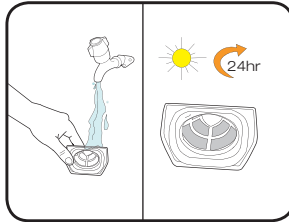

Allow to dry for 24 hrs.

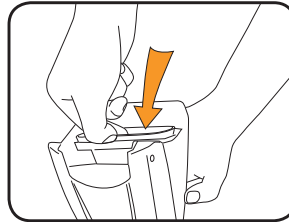

Return filter to dirt container.

## To re-attach dirt container

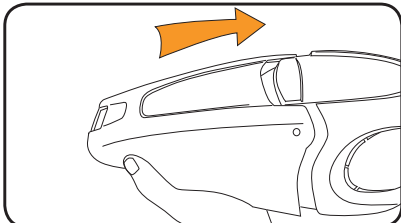

Align bottom of the dirt container first and clip nozzle on.

# FAQs



**WARNING:** To reduce the risk of personal injury, unplug the vacuum cleaner before performing maintenance/ troubleshooting checks.

## Why will the handheld not run?

- The battery may not be charged. To charge the battery, the power switch must be in the 'OFF' position. The red light shows the unit is charging. The initial charge should be for 16 hrs.
- For further assistance, please call us on:  
AU: 1300 361 505  
NZ: 0800 800 900

## Why won't the handheld pick up?

- The nozzle or crevice tool may be blocked, remove the obstruction.
- The filter may be clogged or dirty, clean the filter. Refer to Maintenance Section.
- The battery charge is getting weak, let the battery run until it slows and recharge.
- The dirt container is full, empty the container.
- For further assistance, please call us on:  
AU: 1300 361 505  
NZ: 0800 800 900

## Why won't the battery recharge?

- Check the vacuum is switched off.
- The charger may not be inserted correctly.
- Check the mains power is switched on.
- The electrical outlet may not be working, check the fuse or breaker and consult an electrician.
- For further assistance, please call us on:  
AU: 1300 361 505  
NZ: 0800 800 900



we  to help

Don't take your machine back to the shop, simply contact us

[www.vax.com.au](http://www.vax.com.au)

AU: 1300 361 505  
NZ: 0800 800 900

# Other Information

## Vax Service & Help

Vax Customer Careline AU: 1300 361 505 / NZ: 0800 800 900

Monday - Friday 8.30am to 5.30pm

Any queries or concerns about using the Vax, call the Vax Careline. Calls are charged at the standard national rate.

Please make a note of the serial number and model number of the carpet cleaner before calling. For the nearest Service Agent, please call the Vax Customer Careline or visit [www.vax.com.au](http://www.vax.com.au)

## Technical Specification

### Handheld Unit

Capacity:	250mL
Weight:	1.57kg
Filter:	Washable

### Battery & Charger

Battery Voltage:	15.6V
Runtime:	8mins
Charger Input:	220-240V ~ 50Hz
Initial Charge Time:	16 hrs
Battery Type:	NiCad

Subject to technical change without notice.



Double Insulated



Indoor Use



Read Instructions



Waste electrical products should not be disposed of with household waste. Please recycle where facilities exist. Check with your Local Authority or retailer for recycling advice.

# Notes

# Notes

10

Vax Service line  
AU: 1300 361 505 / NZ: 0800 800 900

# Notes



we  clean

Distributed by Techtronic Industries Ptd. Ltd.  
Level 1. 666 Doncaster Rd, Doncaster, Australia 3108.  
[www.vax.com.au](http://www.vax.com.au) Service Line: AU: 1300 361 505 / NZ: 0800 800 900